



London Glass Installation Instructions **Self Adhesive Backing**

1. Approval of tiles prior to fixing.

Before commencing installation, it is recommended to randomly select an acceptable blend of tiles from different boxes.

2. Work Safety.

Wear protective equipment such as gloves and goggles or safety glasses.

3. Preparing the surfaces.

Before fitting glass tiles as a wall covering, ensure that the surface is flat, non-porous, dry and dust free. Porous surfaces such as plaster should be primed with a suitable primer.

Do not fit glass tiles to walls that may become damp.

Ensure that the reverse of the glass is not scratched or damaged in any way.

4. Fixing using self adhesive backing.

Check the dimensions and allow a 3mm tolerance for easy fitting. Firstly offer up the tile to the desired position and check the size. Take the tile away keeping all corners safe from hard surfaces. Remove the self adhesive liner. Fit the tile in the correct position and apply firm hand pressure.

For splash backs see separate assembly guide.

5. Note.

Milkyway Silver is not suitable for use in swimming pools. In damp/humid areas it should always be coated with foil before installation.

N & C LiveTile.

May 2007.

For and on behalf of : **N & C LiveTile**
Treseburg s.r.o
Domky 578
460 10 Liberec
Czech Republic

Tel: + 420 485 105 581
Fax: + 420 485 105 615
Email: sales@livetile.com

ASSEMBLY GUIDE - Self Adhesive Backing

Component parts

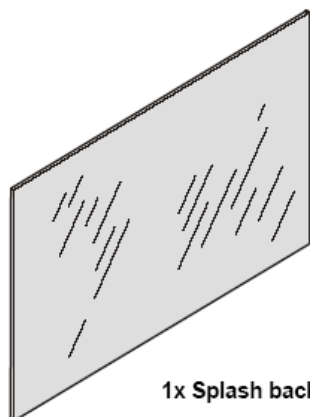

1x Splash back

Tools required (Not Supplied)

Tape measure

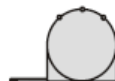

Sealant Gun



Silicone Sealant



BEFORE YOU START...

Check the pack and make sure all the components are included. If not, call +420 485 105 581 or visit www.livetile.com and our team will get things sorted. When you are ready to start make sure you have the right tools to hand. Don't rush, read the instructions first and run through the sequence before you begin.

- Cleaning** - Use mild soap and water only. Do not use abrasive cleaners.

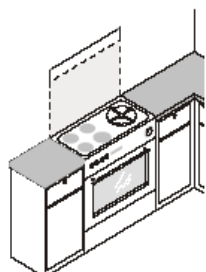

1 First check the dimensions.

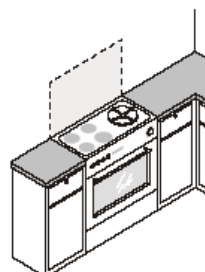

2 Ensure that the surface being fixed to is flat, non porous, dry and dust free.

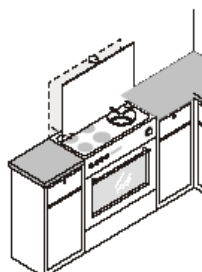

3 Firstly offer up the back of the splash back to the worktop/wall to check the fit.

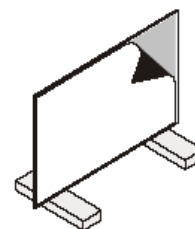

4 Take the splashback away making sure to keep all corners safe from hard surfaces, then remove the covering from the self adhesive backing.

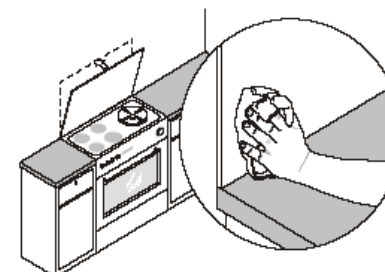

5 Place the bottom edge of the splash back on the top rear edge of the range/hob or worktop, then push the splash back to the wall and apply firm pressure evenly over the whole surface area.

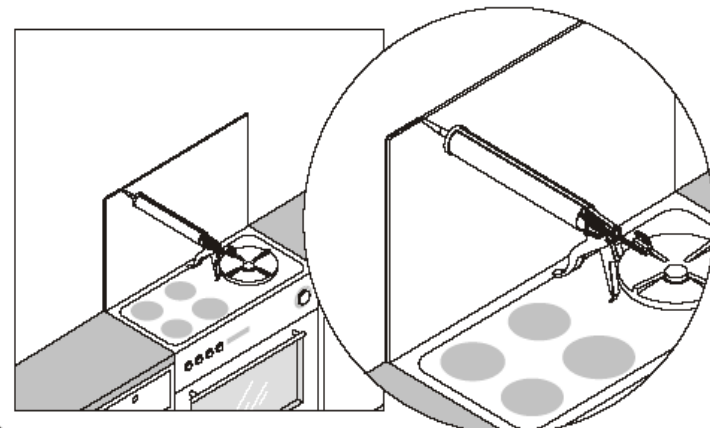

6 Seal the edges of the splash back with a bead of silicone sealant no more than 2.5 mm in thickness.

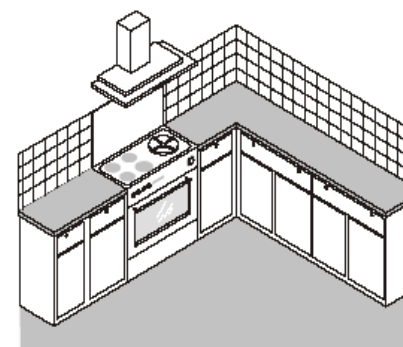
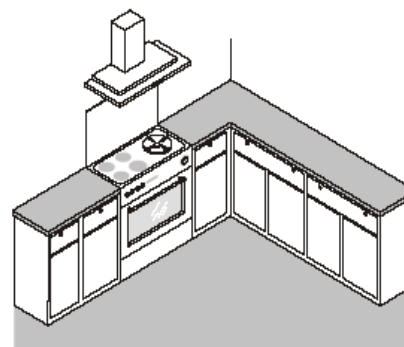



London Glass Installation Instructions **MS Silicone Adhesive**

MS Silicone Polymer adhesive is an all-round durable, flexible adhesive and sealant based on MS Polymer technology. Has excellent adhesion to non-porous surfaces, will bond to damp surfaces and is paintable with most paints. This product is odourless, neutral and is available in White or Clear.

1. Approval of tiles prior to fixing.

Before commencing installation, it is recommended to randomly select an acceptable blend of tiles from different boxes.

2. Work Safety.

Wear protective equipment such as gloves and goggles or safety glasses.

3. Preparing the surfaces.

Surfaces should be flat, sound, and free from dust, dirt and any contamination which may prevent adhesion. Porous surfaces such as concrete should be primed with a suitable primer. Nicobond Primer, diluted 1 part primer to 4 parts water may be used. Allow to dry before proceeding. This may take several hours. For faster drying solvent based primers, consult the Technical Team.

4. Application.

For gluing applications, apply the MS Polymer Adhesive from the gun in vertical lines to the reverse of the tile/panel at intervals up to 30 cm (depending on the size of the glass) and offer up to the surface. Support the application for 24 hours until full curing occurs.

5. Limitations.

Not suitable for application on PE, PP, Teflon and bituminous surfaces, or underwater application. Porous surfaces such as concrete should be primed. Adhesion tests prior to application are recommended.

Health and Safety. May produce an allergic reaction.

6. Note.

Milkyway Silver is not suitable for use in swimming pools. In damp/humid areas it should always be coated with foil before installation.

N & C LiveTile.

May 2007.

For and on behalf of : **N & C LiveTile**
Treseburg s.r.o
Domky 578
460 10 Liberec
Czech Republic

Tel: + 420 485 105 581
Fax: + 420 485 105 615
Email: sales@livetile.com



ASSEMBLY GUIDE - MS Silicone Adhesive

Component parts

1x Shower Splash back

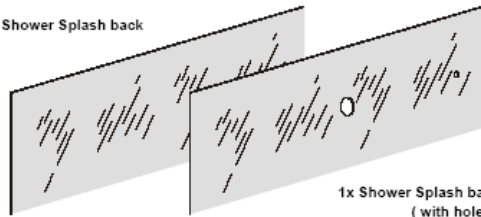

1x Shower Splash back
(with holes)

Tools required (Not Supplied)

Tape measure



Sealant Gun



Silicone Sealant



Glass Sucker

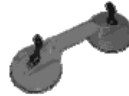

Packers



BEFORE YOU START...

Check the pack and make sure all the components are included. If not, call +420 485 105 581 or visit www.livetile.com and our team will get things sorted. When you are ready to start make sure you have the right tools to hand. Don't rush, read the instructions first and run through the sequence before you begin.

□ **Cleaning** - Use mild soap and water only. Do not use abrasive cleaners.

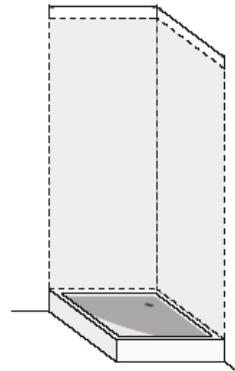

1 First check the dimensions. Ensure surface is flat, non porous, dry and dust free.

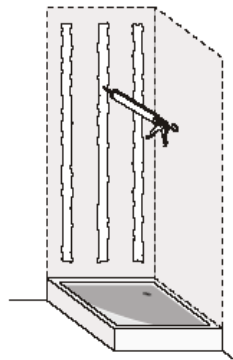

2 Using silicone gun, apply beads to the fixing surface, equally spaced in both directions. Allow enough for the silicone to grab the glass when put into place.

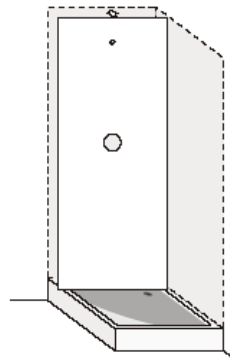

3 Using packers so as to protect the bottom edge of the glass, place the glass so that it is resting just off the shower tray. Evenly apply pressure and push into position. Repeat for each panel being careful not to damage the edges against each other.

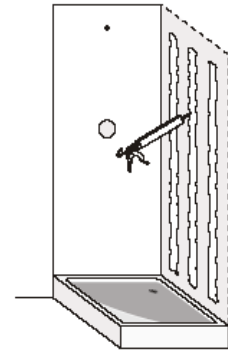

4 Using silicone gun, apply beads to the fixing surface, equally spaced in both directions. Allow enough for the silicone to grab the glass when put into place.

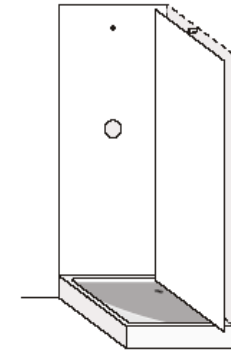

5 Using packers so as to protect the bottom edge of the glass, place the glass so that it is resting just off the shower tray. Evenly apply pressure and push into position. Repeat for each panel being careful not to damage the edges against each other.

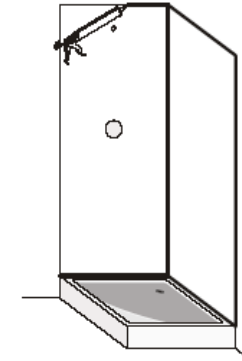

6 Support the application for 24 hours until full curing occurs. Then silicone the edges to ensure a watertight seal.

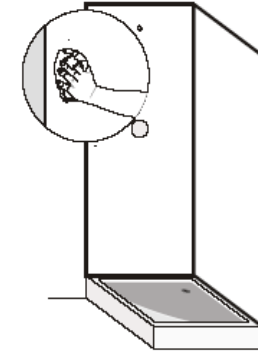

7 Clean off any residual silicone and polish glass!!!